

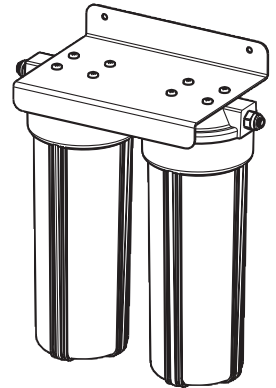

**Puretec**<sup>®</sup>  
PERFECTING WATER



# User Guide

## TS Series

Twin Undersink Drinking Water Systems



**WaterMark**

AS/NZS 3497  
Licence No. WM 74617  
Australian Certification  
Services

**What's inside**

Introduction.....	3
Operation.....	3
Cartridge Replacement Guide.....	4
Installation Requirements.....	4
Installation Procedure.....	5
Parts Description.....	6
SmartTee™ Connection.....	7
Battery Installation.....	8
Quick Connect Fittings.....	9
Performance Data.....	10
Warranty.....	11
Contact Information.....	12

## Puretec Customer Service

Thank you for purchasing a Puretec undersink drinking water system. Your system is a proven performer manufactured from only quality materials and components and will give years of 'spring fresh' water free of impurities if maintained properly.

Caution: Do not use with water that is microbiologically unsafe or with water of unknown quality without adequate disinfection before or after the system.

The system is designed for metropolitan supply water but can be used in other situations. For other types of water supply please contact your local Puretec stockist or call our Puretec Customer Service Helpline.

The Puretec filter systems cartridges need replacing regularly to maintain optimum performance. This is a simple procedure when following instructions. For cartridge replacements contact your nearest Puretec stockist.

Customer Service Helpline **1300 140 140** (Australia) **0800 130 140** (New Zealand).

## Operation

The Puretec undersink systems are designed to run economically for many years, dependent on the initial installation and periodical maintenance.

Flush systems for 10 minutes after any period of non-use more than 2 days. For a period of non-use of 2 weeks or more, it may be necessary to replace cartridges.

This product must be installed in accordance with local plumbing regulations by a licensed plumber.

**Installation Note:** A water filter system/tap, like any product, has a limited life and may eventually fail. Also sometimes failure happens early due to unforeseen circumstances. To avoid possible property damage, this product should be regularly examined for leakage and/or deterioration and replaced when necessary. A drain pan, plumbed to an appropriate drain or outfitted with a leak detector, should be used in those applications where any leakage could cause property damage, and/or the water supply should be turned off if no one is home/present.

## Cartridge Replacement Guide

To maintain the high quality of the purified water the cartridges need changing every 6 - 12 months (dependent on water quality and usage).

You can obtain replacement cartridges from your local Puretec dealer and to maintain performance and warranty use genuine Puretec replacements.

System Model No	Replacement Cartridge
TS100	PX051, GC051
TS200	PX051, CB951

Other cartridges are available to suit a range of requirements upon request.

Important note: When replacing cartridge, ensure you reset the LED reminder light on your filter faucet by removing/replacing the battery from the rubber seat. Please refer to page 8 for a detailed diagram.

## Installation

This system comes complete with an installation kit enabling it to be connected to 15mm (½") copper pipe (cold supply only - hot water should be filtered prior to heating). Included is a control valve incorporating backflow prevention, anti hammer, flow control and pressure limiting capabilities in full compliance with the relevant laws.

## Installation requirements

- 1 13 mm (½") Cold water line.
- 2 Min/Max pressure: 200 - 520 kPa.
- 3 Min/Max temperature 0° - 30°C (protect from freezing).
- 4 Suitable location for faucet.

Alternative fittings may be required if being connected to anything other than 15mm (½") copper pipe. No electrical or drainage requirements needed.

## Installation Procedure

1. Select suitable location that is close to the point of filtered water delivery (eg. sink). Remember to allow access room for changing filters and a suitable place where water spillage will not cause damage. Location should not be in direct sunlight.
2. Isolate water supply. Uninstall the connections on the cold water line and connect the Smart Tee™ (see Fig. 2). Reinstall the previous connection to the tee valve.
3. Connect the pressure limiting multivalve to the Smart Tee™ with a length of white tubing.
4. Choose the best position for the faucet, taking into consideration height of jugs etc. and also the drainage of any spills. Then drill a 12.5mm hole and install the faucet as in step 5.
5. To install faucet, insert the faucet into the hole in sink or bench. Slip the large plastic washer and lock washer onto threaded end of faucet and screw on nut and tighten making sure faucet is correctly positioned on top (see Fig. 1).
6. Reset LED indicator by following instructions on page 8.
7. Install housing assembly by positioning it in the desired location, marking the position of fixing holes and fixing with mounting screws. Allow room for the connecting tubes and for removing the filter bowls (50 mm).
8. Fit tubing into connectors (for quick-connect fittings see fig 4). Allow slack in the tubing. Make sure flow is right according to inlet outlet on housing assembly. For faucet connection see figure 2.
9. Install cartridges as per cartridge installation/changeout.
10. Restore the water supply and check for leaks. The filters need to be only hand tight. If they leak then undo housing and check the O-ring is seated properly.
11. Run the system for at least 10 minutes (push the faucet lever to the upright position) to remove carbon fines. Water may appear milky, but this is normal and is only tiny air bubbles that will clear after a short period.

## Cartridge Installation/Changeout

To change the filter cartridges adhere to the following procedure.

1. Close ballvalve to prevent water flow.
2. Relieve water pressure by operating faucet lever.

3. Unscrew filter housing bowl using the spanner wrench and discard cartridges. When removing housings place a container underneath to catch any spillage.
4. Cleanse the inside of the housing using warm water. Check O-ring and lubricate with food grade silicone lubricant or similar. Replace O-ring if kinked or damaged (Part No: FPOR).
5. Install new cartridges and replace housing screwing them up **HAND TIGHT ONLY**. Sediment filter is on the inlet side and chemical on the outlet side.
6. Reset LED indicator by following instructions on page 8.
7. Restore water supply & check for leaks, rectifying any before leaving the unit.

After installing cartridges flush unit for 5 - 10 minutes.

**Fig. 1 - Parts Description**

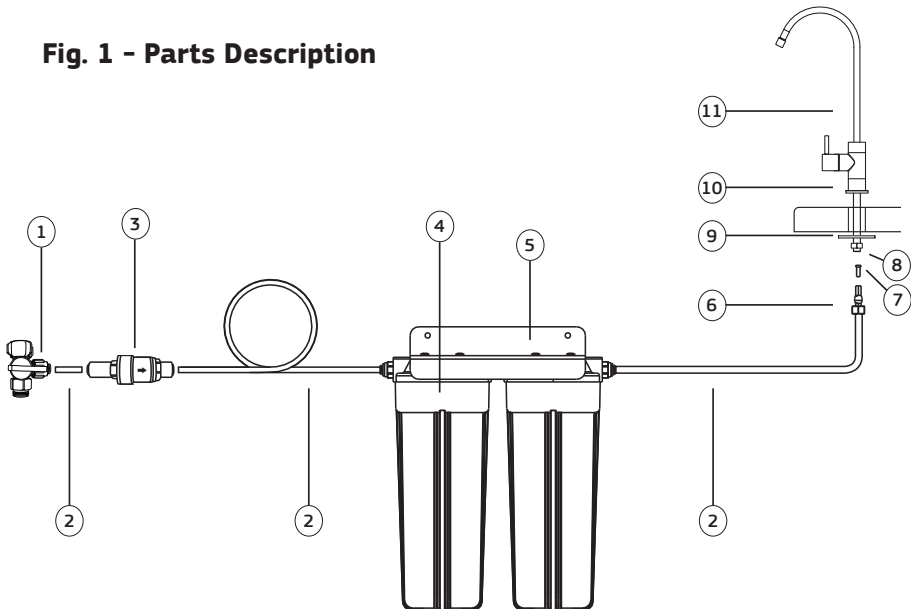

No.	DESCRIPTION
1	Smart Tee™
2	Flexible Tubing
3	Pressure Limiting Multivalve
4	Twin Housing Assembly
5	Mounting Bracket
6	Tube, Nut and Ferrule

7	Tube Insert
8	Faucet Lock Nut and Washer
9	Black Plastic Washer
10	Escutcheon Plate
11	High Loop Faucet

**Fig. 2 - SmartTee™ Quick Connect Fitting**

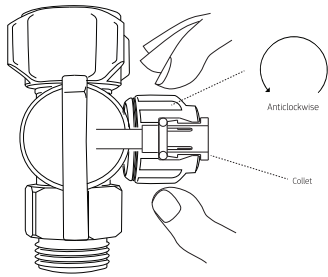

1. Turn the quick connect nut on the SmartTee™ anticlockwise to release the collet.

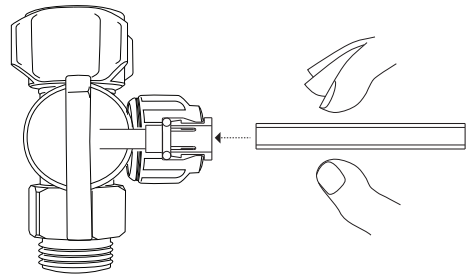

2. Cut the tube square and push into into the tube stop (inside the collet). For metal tube; remove burrs and chamfer tube end to prevent O-ring seal being damaged.

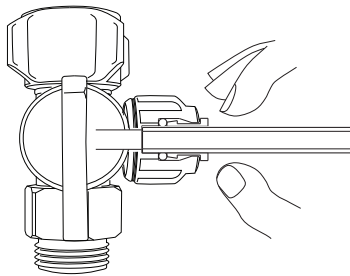

3. The fitting grips before it seals. Ensure the tube is pushed all the way into the tube stop.

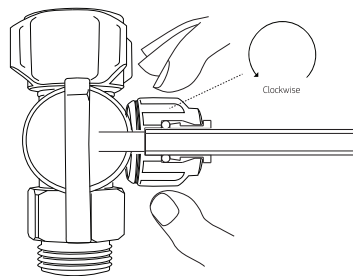

4. Once the tube is secured in position, turn the quick connect nut clockwise to secure.

Note: Hand tighten only. Do not overtighten.

### DISCONNECTION PROCEDURE

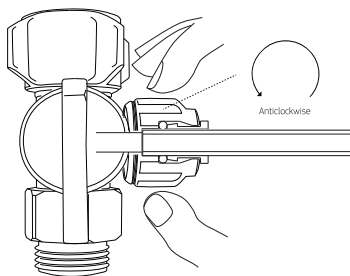

5. Turn the quick connect nut on the SmartTee™ anticlockwise to release the collet.

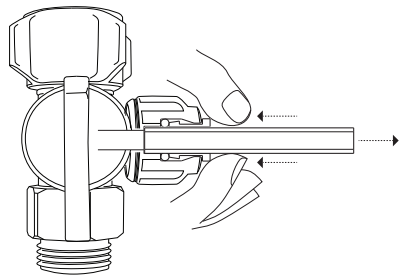

6. Push the collet against the quick connect nut and slide tube out of fitting.

**Fig. 3 - Battery Installation - LED Reminder Light**

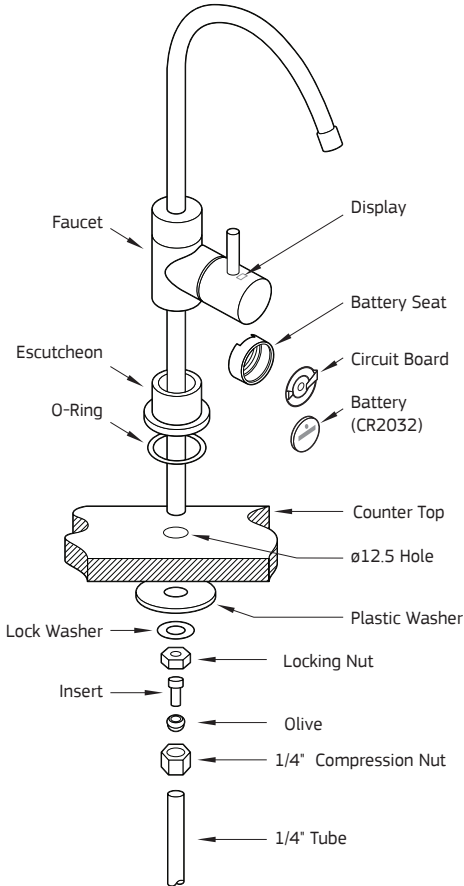

**Important note:** Battery must be replaced when changing cartridges.

1. Remove the black battery seat from the faucet lever handle (see Figure 3).
2. Install battery into the battery seat, positive side up, discard plastic insert.

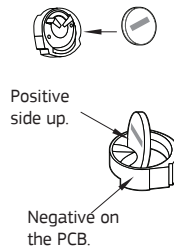

Note: Red light flashes twice and then followed by the blue light.

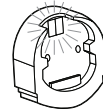

3. Reinstall battery seat assembly into the faucet lever, battery side facing outwards.

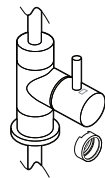

4. Blue light flashes during normal operation.



5. Red light flashes indicates your cartridges are due to be changed (usage has exceeded 3,000 minutes or 12 months). **Please change the battery when changing the cartridges.**

**WARNING!** This product contains a battery. Accidental ingestion may occur and can be fatal. Please keep out of reach from infants. If you suspect an accidental ingestion please contact emergency services.



**Fig. 4 - How To Use Quick Connect Fittings**

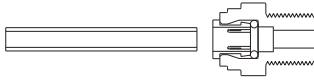

1. Cut the tube square and push in to the tube stop. For metal tube remove burrs and chamfer tube end to prevent O-Ring seal being damaged.

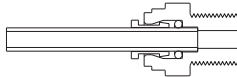

3. Tube is secured in position.

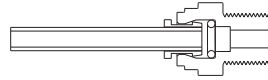

2. Fitting grips before it seals. Ensure tube is pushed in to tube stop.

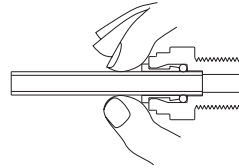

**DISCONNECTION PROCEDURE**

4. Push collet against body and slide tube out of fitting.

## Use Guidelines

- Minimum operating pressure 200 kPa.
- Maximum operating pressure 520 kPa.
- Do not allow exposure to temperatures below 0°C.
- Maximum operating temperature 38°C.
- Nominal flow rate 4 Lpm.
- This system must be installed according to local plumbing codes on the cold water line.
- Replacement Cartridges: See Cartridge replacement section
- This system requires regular replacement of the filter cartridge to maintain proper operation. Varying chlorine, sediment, or organic substance levels may affect replacement frequency.
- Be sure to change the filter cartridge at least every 8,000 litres or 6 - 12 months whichever ever occurs first; or whenever you detect a change in taste, odour, or decrease in flow. 8,000 litres is approximately equal to using 20 litres daily for one year.
- When replacing cartridge, ensure you reset the LED reminder light by removing/replacing the battery from the rubber seat. Please refer to page 8 for a detailed diagram.

Caution: Do not use with water that is microbiologically unsafe or of unknown quality without adequate disinfection before or after the system.

## Performance Data

Substance	Guidelines*	Average Influent Concentration	Max Effluent Concentration	Min Percent Removal	Average Effluent Concentration	Average Percent Removal
<b>NSF Standard 42 Drinking Water Treatment Units</b>						
Chlorine (11,355 L)	5 - Health 0.6 - Aesthetic	2.1	0.3	50%	0.25	>94%
<b>Standard 53 Cyst Live Cryptosporidium POU/POE (TS200)</b>						
Cyst	<1	100,000	ND (1)	99.98% +	ND (1)	99.99%

Test Parameters	
Hardness, Total mg/L	120
TDS mg/L	290
Temp deg C	21°C
Turbidity NTU	0.1
pH	7.57

\*Australian Drinking Water Guidelines - 1996  
ND = Not Detected

This appliance meets the domestic water treatment appliance Standards AS/NZS3497 for the following water treatment processes:

Class	Treatment type	Function	Pass
I	<b>Microbiological Status</b>	Will stop bacteria increasing, but will not remove them unless II(a) is passed	N/A
	Bacteriostatic		
II	<b>Microbiological Treatment</b>		
II (a)	Bacteria Removal	Will remove or inactivate bacteria	N/A
II (b)	Virus Removal	Will remove or inactivate virus	N/A
II (c)	Protozoa Removal	Will remove or inactivate Cryptosporidium and Giardia, but will not remove or inactivate bacteria and viruses unless II(a) and II(b) is passed	YES (TS200)
III	<b>Turbidity &amp; Particulate Reduction</b>	Reduces cloudiness	YES
IV	<b>Taste &amp; Odour Reduction</b>	Reduces taste & odours	YES
V	<b>Chemical Treatment</b>	Decreases chlorine	YES

## **Warranty**

Any claim under this warranty must be made within 3 years of the date of purchase of the product. This product is warrantied to be free of defect of material and workmanship for 3 years from date of purchase. To make a claim under the warranty, take the product and proof of purchase to place where you purchased the product, and they will lodge a Warranty Request with Puretec. 3 year warranty is 1 year parts and labour, plus 2 years parts only.

Puretec will pay your reasonable, direct expenses of claiming under this warranty. You may submit details and proof of your expense claim to place of purchase for consideration.

The warranty only applies if the product was used and/or installed in accordance with the user guide and/or installation instructions. This warranty is given in lieu of all other express or implied warranties and manufacturer shall in no circumstance be held liable for damages consequential or otherwise or delays caused or faulty manufacturing except as excluded by law.

Applicable to all above, is that the warranties need to be approved by Puretec to ensure product was not incorrectly used, installed or claimed. False and incorrect claims will be pursued at Puretec's discretion, including chargeable inspection and labour costs incurred.

## **Warranty/Australia**

This warranty is given by Puretec Pty Ltd, ABN 44 164 806 688, 37-43 Brodie Road, Lonsdale SA 5160, telephone no. 1300 140 140 and email at sales@puretec.com.au.

This warranty is provided in addition to other rights and remedies you have under law: Our goods come with guarantees which cannot be excluded under the Australian Consumer Law. You are entitled to replacement or refund for a major failure and to compensation for other reasonably foreseeable loss or damage. You are also entitled to have the goods repaired or replaced if the goods fail to be of acceptable quality and the failure does not amount to a major failure.

## **Warranty/New Zealand**

This warranty is given by Puretec Ltd, Reg. No 4464398, PO Box 875 Cambridge 3450 NZ, telephone no. 0800 130 140 and email at sales@puretec.co.nz.

This warranty is provided in addition to other rights and remedies you have under law: Our goods come with guarantees which cannot be excluded under the Consumer Guarantees Act. You are entitled to replacement or refund for a major failure and to compensation for other reasonably foreseeable loss or damage. You are also entitled to have the goods repaired or replaced if the goods fail to be of acceptable quality and the failure does not amount to a major failure.



**Puretec**<sup>®</sup>  
PERFECTING WATER

**AUSTRALIA**

P 1300 140 140

E [sales@puretec.com.au](mailto:sales@puretec.com.au)

W [puretec.com.au](http://puretec.com.au)

**NEW ZEALAND**

P 0800 130 140

E [sales@puretec.co.nz](mailto:sales@puretec.co.nz)

W [puretec.co.nz](http://puretec.co.nz)